













Cliquets et douilles

Ratchets and sockets

- P 64 Cliquets / Douilles / Accessoires / Compositions 
 - Ratchets / Sockets / Accessories / Compositions
- P 70 Cliquets / Douilles / Accessoires / Compositions 
 - Ratchets / Sockets / Accessories / Compositions
- P 73 Cliquets / Douilles / Accessoires / Compositions 
 - Ratchets / Sockets / Accessories / Compositions
- P 78 Douilles Tournevis • Screwdriver socket  
- P 80 Compositions Mixtes • Mixed Composition  
- P 82 Cliquet / Douilles / Accessoires / Composition Traversants 
 - Ratchet / Sockets / Accessories / Composition
- P 84 Cliquet / Douilles / Accessoires / Compositions 
 - Ratchet / Sockets / Accessories / Compositions
- P 86 Cliquet / Douilles / Accessoires / Compositions 
 - Ratchet / Sockets / Accessories / Compositions
- P 88 Série Impact  
 - Impact Range



CLIQUETS ET DOUILLES RATCHETS AND SOCKETS



CLIQUET ROND m+b 1/4" - 3/8" - 1/2"

m+b ratchet with Nerotech handle

Sécurité du travail

Verrouillage et déverrouillage rapides des douilles par bouton poussoir. Les douilles ou les accessoires ne se désolidarisent pas du cliquet.

Security of work

Quick locking and unlocking of the sockets with a push button. No risk for sockets or accessories to get lost.



Ergonomie

Le changement du sens de serrage se réalise facilement avec le pouce sur toute la circonférence de la tête.

Ergonomy

Tightening in the opposite direction is easy to carry out with the thumb.

Accessibilité

L'angle de rotation de 5° (cliquet à 72 dents) assure une reprise très performante dans des espaces réduits. Les têtes des cliquets ont un encombrement réduit pour offrir l'accessibilité maximale.

Accessibility

The 5° rotation angle (72 teeth ratchet) allows a very high second operation in narrow spaces. The ratchet heads are very compact to offer a maximum accessibility.

Manche confortable BIMATIERE étudié pour travailler dans toutes les positions : Le polypropylène pour plus de résistance L'élastomère pour une bonne prise en main

Comfortable Nerotech handle studied for working in all positions : Polypropylene for better resistance. Elastomere for a good grip.

MANCHE CONFORTABLE ÉTUDIÉ POUR TRAVAILLER DANS TOUTES LES POSITIONS

Comfortable handle especially designed to work in any position

Prise pleine main :

Forme de manche favorisant naturellement le placement des doigts et assurant une bonne prise nécessaire aux serrages puissants Évasement anti-glissement de la main

Full hand grip:

Handle shape allowing an easy setting of the fingers and a good grip during powerful tightening Widening: hand antisliding

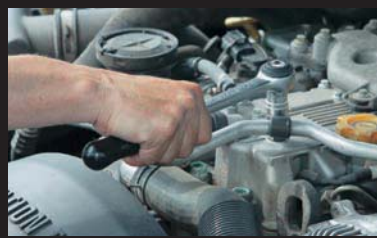

Liaison corps-manche du cliquet étudiée pour ne pas gêner la main lors de la prise

Ratchet body-handle link designed to let the hand free during the grip



Prise inversée facilitée

Easy reversed grip



Saisie en extrémité du manche facilitée grâce à sa forme sphérique

Handle spherical shape to hold it easily by the end



CLIQUETS ET DOUILLES RATCHETS AND SOCKETS

CLIQUET POIRE m+b 1/4" - 1/2"

m+b ratchet 14/1" - 1/2"

Sécurité

Levier de changement de sens intégré dans la tête → pas de risque d'inversion accidentelle

Ergonomie

Changement de sens par le pouce

Visibilité

Le sens est donné par la position du levier

Accessibilité

Faible encombrement de la tête allongée



Safety

Integrated ratchet system

→ No accidental risk of inversion

Ergonomy

one-handed direction reversal

Visibility

The direction is easy to see

Accessibility

Easy handling of the compact head

DOUILLES

Sockets

Résistance

La suppression des angles vifs des carrés augmente leur résistance.

Resistance

The squares sharp edges suppression increases their resistance.



Ergonomie

Pour trouver rapidement la douille souhaitée sa dimension est marquée sur tout le pourtour. La manipulation des douilles est rendue facile grâce à un épaulement extérieur prévu pour la prise.

Ergonomy

The socket is marked all around with its dimension to be found out easily. The sockets handling is easy, thanks to its external shape adequate to a good grip.



6 pans - 12 pans

Puissance

Pour les carrés 1/4", 3/8" et 1/2", m+b propose deux gammes de douilles: - 6 pans pour serrages puissants; - 12 pans pour la mise en place et la reprise facile dans les endroits encombrés. Les profils 6 et 12 pans ont un profil étudié pour augmenter la résistance des douilles et protéger les écrous contre le matage.

6 sides - 12 sides

Power

For 1/4", 3/8" and 1/2" square, m+b offers 2 ranges of sockets: - 6 sides for powerful tightening - 12 sides to ease the setting up and second operation in reduced spaces. The 6 and 12 sides profiles have round angles to increase the sockets resistance and to protect the nut against caulking.

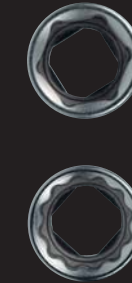

ACCESSOIRES

Accessories



m+b propose pour chaque carré une gamme complète d'accessoires pour répondre à toutes les situations où l'accessibilité est réduite.

m+b offers a complete range of accessories for each square to suit any situation in reduced spaces.



Consultez les consignes de sécurité page 310 - Please refer to the safety rules on page 310



CLIQUETS / DOUILLES / ACCESSOIRES / COMPOSITIONS

RATCHETS / SOCKETS / ACCESSORIES / COMPOSITIONS



9200

CLIQUET ROND MICRO
MICRO NERTECH RATCHET

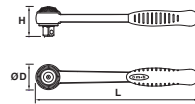

NF ISO 3315/1174 DIN 3122

L mm	ØD mm	H mm	g	Réf.	⊞	⊞	Gencod 3 30380+	€ HT	Réf.	⊞	⊞	Gencod 3 30380+	€ HT
138	26	28	115	9200720001	1	10	9200723	20,85	9200721001	1	10	9200006	22,07

9200

CLIQUET POIRE 1/4"
REVERSIBLE RATCHET PEAR SHAPE 1/4"

L mm	ØD mm	H mm	g	Réf.	⊞	⊞	Gencod 3 30380+	€ HT
143	26	12,5	130	9200720101	1	10	9200730	18,01

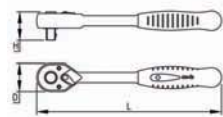

9210

DOUILLE 6 PANS
6 SIDES SOCKET

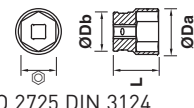

NF ISO 2725 DIN 3124



⊙ mm	ØDb mm	ØDa mm	L mm	g	Réf.	⊞	⊞	Gencod 3 30380+	€ HT	Réf.	⊞	⊞	Gencod 3 30380+	€ HT
3,2	11,85	6	25	9	9210C30001	5	50	9210036	1,69	9210C31001	3	10	9210005	2,44
4	11,85	6,8	25	9	9210040001	5	50	9210043	1,69	9210041001	3	10	9210166	2,44
4,5	11,85	7,4	25	10	9210B40001	5	50	9210012	1,69	9210B41001	3	10	9210029	2,44
5	11,85	8	25	10	9210050001	5	50	9210050	1,69	9210051001	3	10	9210173	2,44
5,5	11,85	8,7	25	10	9210A50001	5	50	9210555	1,69	9210A51001	3	10	9210159	2,44
6	11,85	9,3	25	11	9210060001	5	50	9210067	1,69	9210061001	3	10	9210180	2,44
7	11,85	10,8	25	11	9210070001	5	50	9210074	1,69	9210071001	3	10	9210197	2,44
8	11,85	11,5	25	11	9210080001	5	50	9210081	1,69	9210081001	3	10	9210203	2,44
9	12	12,85	25	12	9210090001	5	50	9210098	1,69	9210091001	3	10	9210210	2,44
10	12	14,35	25	17	9210100001	5	50	9210104	1,73	9210101001	3	10	9210227	2,50
11	14	15,85	25	17	9210110001	5	50	9210111	1,73	9210111001	3	10	9210234	2,50
12	14	16,85	25	18	9210120001	5	50	9210128	1,94	9210121001	3	10	9210241	2,70
13	14	17,85	25	24	9210130001	5	50	9210135	1,94	9210131001	3	10	9210258	2,70
14	14	19,70	25	28	9210140001	5	50	9210142	2,23	9210141001	3	10	9210265	2,98

9216

DOUILLE 12 PANS
12 SIDES SOCKET

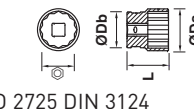

NF ISO 2725 DIN 3124



⊙ mm	ØDb mm	ØDa mm	L mm	g	Réf.	⊞	⊞	Gencod 3 30380+	€ HT
3,2	11,85	6	25	9	9216C30001	5	25	9216038	1,69
4	11,85	6,8	25	9	9216040001	5	25	9216045	1,69
4,5	11,85	7,4	25	10	9216B40001	5	25	9216014	1,69
5	11,85	8	25	10	9216050001	5	25	9216052	1,69
5,5	11,85	8,7	25	10	9216A50001	5	25	9216557	1,69
6	11,85	9,3	25	11	9216060001	5	25	9216069	1,69
7	11,85	10,8	25	11	9216070001	5	25	9216076	1,69
8	11,85	11,5	25	11	9216080001	5	25	9216083	1,69
9	12	12,85	25	12	9216090001	5	25	9216090	1,69
10	12	14,35	25	17	9216100001	5	25	9216106	1,73
11	14	15,85	25	17	9216110001	5	25	9216113	1,73
12	14	16,85	25	18	9216120001	5	25	9216120	1,94
13	14	17,85	25	24	9216130001	5	25	9216137	1,94
14	14	19,7	25	28	9216140001	5	25	9216144	2,23

9220

DOUILLE 6 PANS SÉRIE LONGUE
6 SIDES SOCKET LONG SERIES

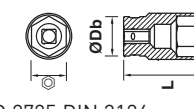

NF ISO 2725 DIN 3124



⊙ mm	ØDb mm	ØDa mm	L mm	g	Réf.	⊞	⊞	Gencod 3 30380+	€ HT
3,2	11,85	6	50	15	9220C30001	5	25	9220035	6,78
4	11,85	6,8	50	16	9220040001	5	25	9220042	6,78
4,5	11,85	7,4	50	17	9220B40001	5	25	9220011	6,78
5	11,85	8	50	18	9220050001	5	25	9220059	6,78
5,5	11,85	8,7	50	18	9220A50001	5	25	9220554	6,78
6	11,85	9,3	50	18	9220060001	5	25	9220066	6,78
7	11,85	10,8	50	21	9220070001	5	25	9220073	6,78
8	11,85	11,5	50	21	9220080001	5	25	9220080	6,78
9	12	12,85	50	27	9220090001	5	25	9220097	6,78
10	12	14,35	50	33	9220100001	5	25	9220103	6,98
11	14	15,85	50	39	9220110001	5	25	9220110	6,98
12	14	16,85	50	43	9220120001	5	25	9220127	7,75
13	14	17,85	50	43	9220130001	5	25	9220134	7,75
14	14	19,7	50	54	9220140001	5	25	9220141	8,91

CLIQUETS / DOUILLES / ACCESSOIRES / COMPOSITIONS

RATCHETS / SOCKETS / ACCESSORIES / COMPOSITIONS

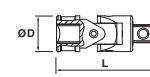

NF ISO 3316 - DIN 3123

9250

CARDAN UNIVERSEL
UNIVERSAL JOINT



L mm	ØD mm	g	Réf.	⊞	⊞	Gencod 3 30380+	€ HT	Réf.	⊞	⊞	Gencod 3 30380+	€ HT
38	14	25	9250000001	1	10	9250001	8,72	9250001001	1	10	9250018	9,57

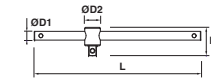

NF ISO 3315 - DIN 3122

9270

POIGNÉE COULISSANTE
T-HANDLE WITH SLIDING SQUARE DRIVE



L mm	ØD1 mm	ØD2 mm	H mm	g	Réf.	⊞	⊞	Gencod 3 30380+	€ HT	Réf.	⊞	⊞	Gencod 3 30380+	€ HT
115	6,3	13,3	24	50	9270110001	1	10	9270115	4,37	9270111001	1	10	9270122	5,11

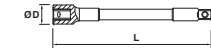

NF ISO 3316 - DIN 3123

9260

RALLONGE
EXTENSION BAR



L mm	ØD mm	g	Réf.	⊞	⊞	Gencod 3 30380+	€ HT	Réf.	⊞	⊞	Gencod 3 30380+	€ HT
50	12	24	9260050001	1	10	9260055	3,28	9260051001	1	10	9260017	3,99
75	12	35	9260070001	1	10	9260079	3,39					
125	12	57	9260120001	1	10	9260123	3,51	9260121001	1	10	9260130	4,24

9260

RALLONGE FLEXIBLE
FLEXIBLE EXTENSION BAR

L mm	ØD mm	g	Réf.	⊞	⊞	Gencod 3 30380+	€ HT
150	12	64	9260000001	1	10	9260000	9,21



9284

POIGNÉE ARTICULÉE
HINGED HANDLE

H mm	L mm	g	Réf.	⊞	⊞	Gencod 3 30380+	€ HT
21	150	92	9284150001	1	10	9284150	12,12

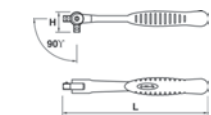

9290

AUGMENTATEUR CARRE
1/4" À 3/8"
COUPLER SQUARE
1/4" TO 3/8"

ØD mm	L mm	g	Réf.	⊞	⊞	Gencod 3 30380+	€ HT
12	25	15	9290380001	1	10	9290120	3,65





9410-01 9410-03

COFFRETS MÉTALLIQUES DE 20 PIÈCES 1/4"
(cliquet monomatériau)
20 PIECES 1/4" SETS IN METALBOX
(monomaterial ratchet)

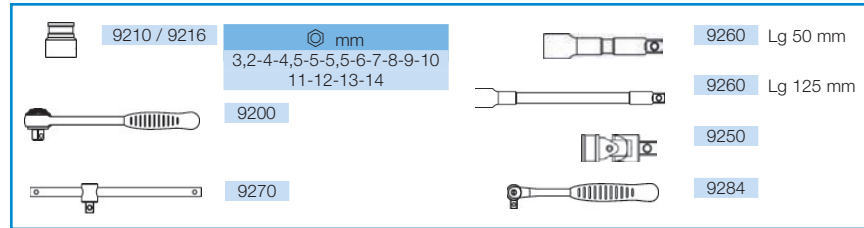

Dimensions mm	📦	Réf.	📦	📏	Gencod 3 30380+	€ HT
240 x 160 x 42	1200	9410010001	1	10	9410016	76,16
240 x 160 x 42	1200	9410030001	1	10	9410030	76,16



9410-02

COFFRET MÉTALLIQUE DE 31 PIÈCES 1/4"
(cliquet monomatériau)
31 PIECES" 6 SIDES 1/4" SET IN METALBOX
(monomaterial ratchet)

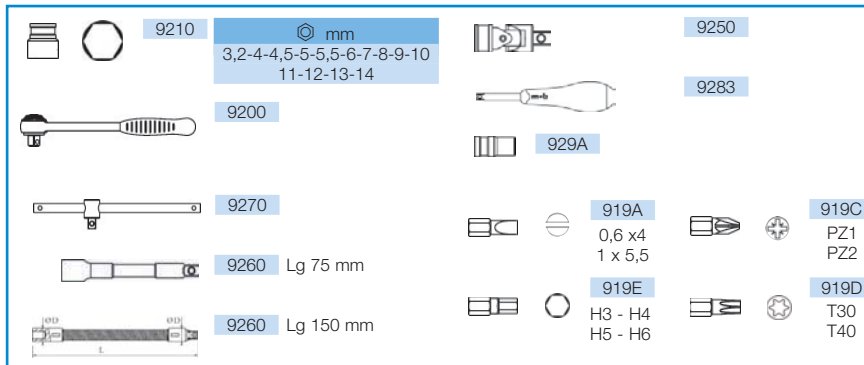

Dimensions mm	📦	Réf.	📦	📏	Gencod 3 30380+	€ HT
240 x 160 x 42	1280	9410020001	1	10	9410023	93,18



1/4"



9410-31

COFFRETS PLASTIQUES DE 31 PIÈCES BIMATIÈRE 1/4"
31 PIECES 1/4" SET IN PLASTIC BOX

nouveauté
NEW

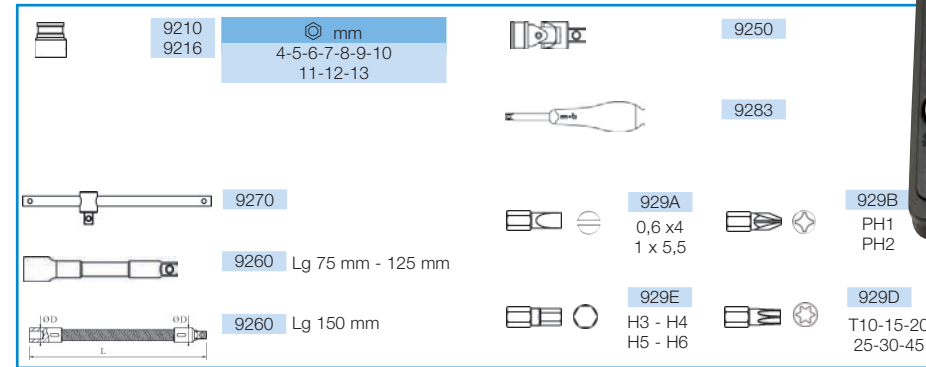

Dimensions mm	📦	Réf.	📦	📏	Gencod 3 30380+	€ HT
260 x 175 x 60	1115	9410310101	1	10	9410047	74,56
260 x 175 x 60	1115	9410311101	1	10	9004390	74,56
260 x 175 x 60	1115	9410310001	1	10	9004383	77,41
260 x 175 x 60	1115	9410311001	1	10	9004406	77,41

1/4"



9410-41

COFFRETS PLASTIQUES DE 41 PIÈCES BIMATIÈRE 1/4"
41 PIECES 1/4" SET IN PLASTIC BOX

nouveauté
NEW

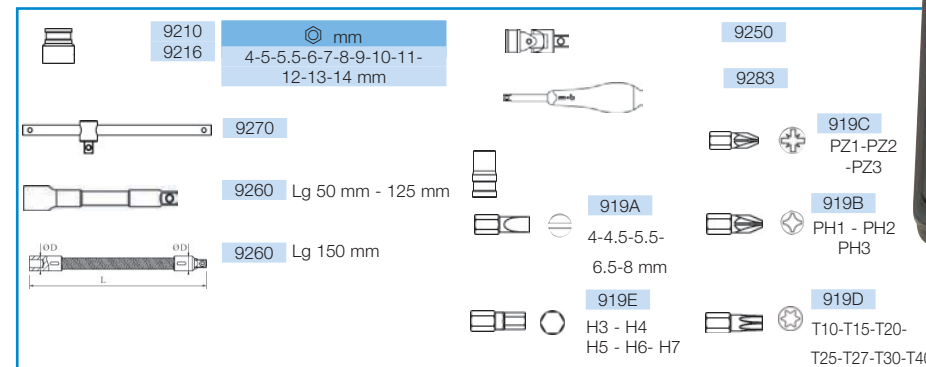

Dimensions mm	📦	Réf.	📦	📏	Gencod 3 30380+	€ HT
260x175x60	990	9410410101	1	10	9005687	85,81
260x175x60	990	9410411101	1	10	9005700	85,81
260x175x60	990	9410410001	1	10	9005694	89,43
260x175x60	990	9410411001	1	10	9005717	89,43



CLIQUETS / DOUILLES / ACCESSOIRES / COMPOSITIONS

RATCHETS / SOCKETS / ACCESSORIES / COMPOSITIONS



NF ISO 3315 / 1174 DIN 3122

9201	L mm	ØDmm	H mm	g	Réf.	1	10	Gencod	€ HT
CLIQUET MEDIUM MEDIUM RATCHET	192	31	34	218	9201720001	1	10	9201720	23,26



NF ISO 2725 DIN 3124

9211	L mm	ØDmm	H mm	g	Réf.	1	10	Gencod	€ HT
DOUILLE 6 PANS 6 SIDES SOCKET									

Ø mm	ØDb mm	ØDa mm	L mm	g	Réf.	1	10	Gencod 3 30380+	€ HT
7	16,9	10,7	30	24	9211070001	5	50	9211071	2,89
8	16,9	11,9	30	24	9211080001	5	50	9211088	2,89
9	16,9	13,2	30	25	9211090001	5	50	9211095	2,89
10	16,9	14,4	30	25	9211100001	5	50	9211101	2,89
11	16,9	15,7	30	25	9211110001	5	50	9211118	2,89
12	16,9	16,4	30	27	9211120001	5	50	9211125	3,15
13	17	17,8	30	28	9211130001	5	50	9211132	3,15
14	17,5	19,7	30	37	9211140001	5	50	9211149	3,15
15	18	21	30	42	9211150001	5	50	9211156	3,15
16	18	21,8	30	47	9211160001	5	50	9211163	3,39
17	19	23,8	30	57	9211170001	5	50	9211170	3,39
18	20	24,6	30	61	9211180001	5	50	9211187	3,39
19	20	25,7	30	62	9211190001	5	50	9211194	3,39
20	20	27,2	30	75	9211200001	5	50	9211200	3,87
21	22	28	30	78	9211210001	5	50	9211217	3,87
22	22	29,7	30	92	9211220001	5	50	9211224	3,87
23	22	31	30	93	9211230001	5	50	9211231	4,37
24	22	31,9	30	109	9211240001	5	50	9211248	4,37



NF ISO 2725 DIN 3124

9217	L mm	ØDmm	H mm	g	Réf.	1	10	Gencod	€ HT
DOUILLE 12 PANS 12 SIDES SOCKET									

Ø	ØDb	ØDa	L	g	Réf.	1	10	Gencod	€ HT
7	16,9	10,7	30	24	9217070001	5	25	9217073	2,89
8	16,9	11,9	30	24	9217080001	5	25	9217080	2,89
9	16,9	13,2	30	25	9217090001	5	25	9217097	2,89
10	16,9	14,4	30	25	9217100001	5	25	9217103	2,89
11	16,9	15,7	30	25	9217110001	5	25	9217110	2,89
12	16,9	16,4	30	27	9217120001	5	25	9217127	3,15
13	17	17,8	30	28	9217130001	5	25	9217134	3,15
14	17,5	19,7	30	37	9217140001	5	25	9217141	3,15
15	18	21	30	42	9217150001	5	25	9217158	3,15
16	18	21,8	30	47	9217160001	5	25	9217165	3,39
17	19	23,8	30	57	9217170001	5	25	9217172	3,39
18	20	24,6	30	61	9217180001	5	25	9217189	3,39
19	20	27,2	30	62	9217190001	5	25	9217196	3,39
20	20	27,2	30	75	9217200001	5	25	9217202	3,87
21	22	28	30	78	9217210001	5	25	9217219	3,87
22	22	29,7	30	92	9217220001	5	25	9217226	3,87
23	22	31	30	93	9217230001	5	25	9217233	4,37
24	22	31,9	30	109	9217240001	5	25	9217240	4,37



NF ISO 2725 DIN 3124

9226	L mm	ØDmm	H mm	g	Réf.	1	10	Gencod	€ HT
DOUILLE 12 PANS SÉRIE LONGUE 12 SIDES SOCKET LONG SERIES									

Ømm	ØDb mm	ØDa mm	L mm	g	Réf.	1	10	Gencod 3 30380+	€ HT
7	16,9	10,7	63	48	9226070001	5	25	9226075	8,15
8	16,9	11,9	63	49	9226080001	5	25	9226082	8,15
9	16,9	13,2	63	52	9226090001	5	25	9226099	8,15
10	16,9	14,4	63	52	9226100001	5	25	9226105	8,15
11	16,9	15,7	63	60	9226110001	5	25	9226112	8,15
12	16,9	16,4	63	73	9226120001	5	25	9226129	8,82
13	17	17,8	63	74	9226130001	5	25	9226136	8,82
14	17,5	19,7	63	79	9226140001	5	25	9226143	8,82
15	18	21	63	84	9226150001	5	25	9226150	8,82
16	18	21,8	63	97	9226160001	5	25	9226167	9,50
17	19	23,8	63	123	9226170001	5	25	9226174	9,50
18	20	24,6	63	124	9226180001	5	25	9226181	9,50
19	20	25,7	63	138	9226190001	5	25	9226198	9,50
20	20	27,2	63	157	9226200001	5	25	9226204	10,85
21	22	28	63	164	9226210001	5	25	9226211	10,85
22	22	29,7	63	188	9226220001	5	25	9226228	10,85
23	22	31	63	194	9226230001	5	25	9226235	12,20
24	22	31,9	63	210	9226240001	5	25	9226242	12,20

CLIQUETS / DOUILLES / ACCESSOIRES / COMPOSITIONS

RATCHETS / SOCKETS / ACCESSORIES / COMPOSITIONS



S inch	L mm	g	Réf.	1	10	Gencod 3 30380+	€ HT
3/8	25	30	929A000201	5	25	9290281	5,27



929A	L mm	ØDmm	H mm	g	Réf.	1	10	Gencod	€ HT
DOUILLE PORTE-EMBOUS 6 PANS BIT HOLDER SOCKET 6 SIDES									

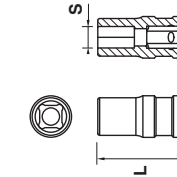

L mm	ØD mm	g	Réf.	1	10	Gencod 3 30380+	€ HT
50	18	60	9251000001	1	10	9251015	13,56



9251	L mm	ØD mm	H mm	g	Réf.	1	10	Gencod	€ HT
CARDAN UNIVERSEL UNIVERSAL JOINT									

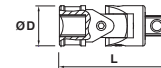

NF ISO 3316 - DIN 3123

L mm	ØD1mm	ØD2mm	H mm	g	Réf.	1	10	Gencod 3 30380+	€ HT
200	10,7	18,5	33	145	9271200001	1	10	9271204	7,75



9271	L mm	ØD1mm	ØD2mm	H mm	g	Réf.	1	10	Gencod	€ HT
POIGNÉE COULISSANTE T-HANDLE WITH SLIDING SQUARE DRIVE										

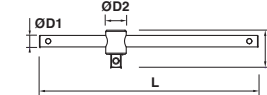

NF ISO 3315 - DIN 3122



ØD mm	L mm	g	Réf.	1	10	Gencod 3 30380+	€ HT
18	75	80	9261070001	1	10	9261076	5,57
18	125	115	9261200001	1	10	9261120	5,82
18	250	205	9261250001	1	10	9261052	7,51



9261	L mm	ØD mm	H mm	g	Réf.	1	10	Gencod	€ HT
RALLONGE EXTENSION BAR									

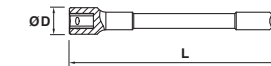

NF ISO 3316 - DIN 3123



H mm	L mm	g	Réf.	1	10	Gencod 3 30380+	€ HT
28	250	330	9285250101	1	10	9007537	15,96



9285	L mm	ØD mm	H mm	g	Réf.	1	10	Gencod	€ HT
POIGNÉE ARTICULÉE HINGED HANDLE									

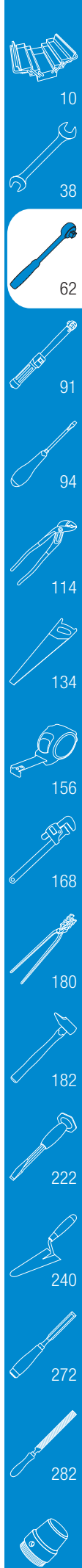



9291

RÉDUCTEUR CARRE 3/8" À 1/4" COUPLER 3/8" TO 1/4"

ØD mm	L mm	g	Réf.	1	10	Gencod 3 30380+	€ HT
18	30	27	9291140001	1	10	9290144	5,33

9291

AUGMENTATEUR CARRE 3/8" À 1/2" COUPLER 3/8" TO 1/2"

ØD mm	L mm	g	Réf.	1	10	Gencod 3 30380+	€ HT
18	30	42	9291120001	1	10	9290151	6,30



9420-01 9420-02

COFFRETS MÉTALLIQUE DE 23 PIÈCES 3/8"
(cliquet monomatériau)
23 PIECES 3/8" SETS IN METALBOX
(monomaterial ratchet)

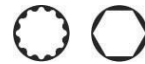

9217	Ø mm	9251
7-8-9-10-11-12-13-14-15-16-17-18-19-20-21-22-23-24		
9201		9261 Lg 125 mm
9271		9261 Lg 250 mm

Dimensions mm	g	Réf.	1	10	Gencod 3 30380+	€ HT
355 x 185 x 55	3200	9420010001	1	10	9420015	116,60
355 x 185 x 55	3200	9420020001	1	10	9420022	116,60



9202

CLIQUET ROND 1/2" NERTECH PREMIUM NERTECH RATCHET

L mm	ØD mm	H mm	g	Réf.	1	10	Gencod 3 30380+	€ HT
243	38	45	490	9202720001	1	10	9202727	33,33

9202

CLIQUET POIRE 1/2" REVERSIBLE RATCHET 1/2"

L	ØD mm	H mm	g	Réf.	1	10	Gencod	€ HT
263	40	20,5	595	9202720101	1	10	9202734	27,25

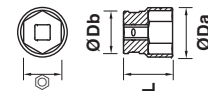

NF ISO 2725 DIN 3124

Ø mm	ØDb mm	ØDa mm	L mm	g	Réf.	1	10	Gencod 3 30380+	€ HT	Réf.	1	10	Gencod 3 30380+	€ HT
8	22	12,8	38	44	9212080001	5	50	9112088	2,90	9212081001	3	10	9212818	3,54
9	22	14,2	38	45	9212090001	5	50	9112095	2,90	9212091001	3	10	9212832	3,54
10	22	15,3	38	49	9212100001	5	50	9112101	2,90	9212101001	3	10	9212849	3,54
11	22	16,5	38	50	9212110001	5	50	9112118	2,90	9212111001	3	10	9212856	3,54
12	22	17,8	38	51	9212120001	5	50	9112125	3,13	9212121001	3	10	9212863	3,79
13	22	19	38	53	9212130001	5	50	9112132	3,13	9212131001	3	10	9212870	3,79
14	22	20,3	38	55	9212140001	5	50	9112149	3,13	9212141001	3	10	9212887	3,79
15	22	21,5	38	58	9212150001	5	50	9112156	3,13	9212151001	3	10	9212894	3,79
16	22	23	38	62	9212160001	5	50	9112163	3,24	9212161001	3	10	9212900	3,91
17	22	24	38	64	9212170001	5	50	9112170	3,31	9212171001	3	10	9212917	3,98
18	22	25,3	38	68	9212180001	5	50	9112187	3,34	9212181001	3	10	9212924	4,01
19	24	26,5	38	68	9212190001	5	50	9112194	3,50	9212191001	3	10	9212931	4,16
20	24	28	38	78	9212200001	5	50	9112200	3,61	9212201001	3	10	9212948	4,27
21	25	29	38	85	9212210001	5	50	9112217	3,76	9212211001	3	10	9212955	4,44
22	25	30	40	90	9212220001	5	50	9112224	3,93	9212221001	3	10	9212962	4,60
23	26	31	40	94	9212230001	5	50	9112231	3,97	9212231001	3	10	9212969	4,64
24	26	33	40	102	9212240001	5	50	9112248	4,13	9212241001	3	10	9212976	4,81
25	26	34	42	102	9212250001	5	50	9112255	4,28					
26	28	35	45	110	9212260001	5	50	9112262	4,48	9212261001	3	10	9212986	5,15
27	28	36	45	110	9212270001	5	50	9112279	4,62	9212271001	3	10	9212993	5,30
28	28	38	45	112	9212280001	5	50	9112286	4,85					
29	28	39	45	112	9212290001	5	50	9112293	5,02					
30	28	40	45	116	9212300001	5	50	9112309	5,19	9212301001	3	10	9212009	5,89
32	28	42	45	116	9212320001	5	50	9112323	5,29	9212321001	3	10	9212016	6,02

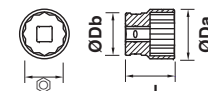

NF ISO 2725 DIN 3124

Ø mm	ØDb mm	ØDa mm	L mm	g	Réf.	1	10	Gencod 3 30380+	€ HT	Réf.	1	10	Gencod 3 30380+	€ HT
8	22	12,8	38	44	9215080001	5	25	9215086	2,90	9215081001	3	10	9215819	3,54
9	22	14,2	38	45	9215090001	5	25	9215093	2,90	9215091001	3	10	9215826	3,54
10	22	15,3	38	49	9215100001	5	25	9215109	2,90	9215101001	3	10	9215833	3,54
11	22	16,5	38	50	9215110001	5	25	9215116	2,90	9215111001	3	10	9215840	3,54
12	22	17,8	38	51	9215120001	5	25	9215123	3,13	9215121001	3	10	9215857	3,79
13	22	19	38	53	9215130001	5	25	9215130	3,13	9215131001	3	10	9215864	3,79
14	22	20,3	38	55	9215140001	5	25	9215147	3,13	9215141001	3	10	9215888	3,79
15	22	21,5	38	58	9215150001	5	25	9215154	3,13	9215151001	3	10	9215895	3,79
16	22	23	38	62	9215160001	5	25	9215161	3,24	9215161001	3	10	9215901	3,91
17	22	24	38	64	9215170001	5	25	9215178	3,31	9215171001	3	10	9215918	3,98
18	22	25,3	38	68	9215180001	5	25	9215185	3,34	9215181001	3	10	9215925	4,01
19	24	26,5	38	68	9215190001	5	25	9215192	3,50	9215191001	3	10	9215932	4,16
20	24	28	38	78	9215200001	5	25	9215208	3,61	9215201001	3	10	9215949	4,27
21	25	29	38	85	9215210001	5	25	9215215	3,76	9215211001	3	10	9215956	4,44
22	25	30	40	90	9215220001	5	25	9215222	3,93	9215221001	3	10	9215963	4,60
23	26	31	40	94	9215230001	5	25	9215239	3,97	9215231001	3	10	9215970	4,64
24	26	33	40	102	9215240001	5	25	9215246	4,13	9215241001	3	10	9215987	4,81
25	26	34	42	102	9215250001	5	25	9215253	4,28	9215251001	3	10	9215994	4,97
26	28	35	45	110	9215260001	5	25	9215260	4,48	9215261001	3	10	9215000	5,15
27	28	36	45	110	9215270001	5	25	9215277	4,62	9215271001	3	10	9215017	5,30
28	28	38	45	112	9215280001	5	25	9215284	4,85	9215281001	3	10	9215024	5,55
29	28	39	45	112	9215290001	5	25	9215291	5,02	9215291001	3	10	9215031	5,70
30	28	40	45	116	9215300001	5	25	9215307	5,19	9215301001	3	10	9215048	5,89
32	28	42	45	116	9215320001	5	25	9215321	5,29	9215321001	3	10	9215055	6,02



9227

DOUILLE 12 PANS SÉRIE LONGUE
12 SIDES SOCKET LONG SERIES

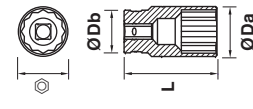

NF ISO 2725 DIN 3124



Ø mm	ØDb mm	ØDa mm	L mm	g	Réf.	1	10	Gencod 3 30380+	€ HT
12	22	17,8	78	128	9227120001	5	25	9227126	8,41
13	22	19	78	130	9227130001	5	25	9227133	8,41
14	22	20,3	78	132	9227140001	5	25	9227140	8,41
15	22	21,5	78	132	9227150001	5	25	9227157	8,41
16	22	23	78	140	9227160001	5	25	9227164	8,70
17	22	24	78	150	9227170001	5	25	9227171	8,90
18	22	25,3	78	160	9227180001	5	25	9227188	8,99
19	24	26,5	78	160	9227190001	5	25	9227195	9,40
20	24	28	78	175	9227200001	5	25	9227201	9,68
21	25	29	78	180	9227210001	5	25	9227218	10,11
22	25	30	78	180	9227220001	5	25	9227225	10,53
23	26	31	78	190	9227230001	5	25	9227232	10,67
24	26	33	78	195	9227240001	5	25	9227249	11,08
25	26	34	78	195	9227250001	5	25	9227256	11,50
26	28	35	78	195	9227260001	5	25	9227263	11,99
27	28	36	78	200	9227270001	5	25	9227270	12,41
28	28	38	78	200	9227280001	5	25	9227287	13,02
29	28	39	78	200	9227290001	5	25	9227294	13,44
30	28	40	78	205	9227300001	5	25	9227300	13,93
32	28	42	78	205	9227320001	5	25	9227324	14,63



9430

JEU 14 DOUILLES LONGUES SUR RACK
14 PIECES DEEP SOCKET SET

picto	Dimensions mm	L mm	g	Réf.	1	10	Gencod 3 30380+	€ HT
	12-13-14-15-16-17-18-19-20-21-22-23-24-27 mm	445	2200	9430070001	1	10	9430076	131,04
	12-13-14-15-16-17-18-19-20-21-22-23-24-27 mm	440	2300	9430080001	1	10	9000446	131,04

9252

CARDAN UNIVERSEL
UNIVERSAL JOINT

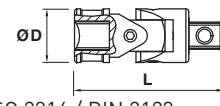

NF ISO 3316 / DIN 3123



L mm	ØD mm	g	Réf.	1	10	Gencod 3 30380+	€ HT	Réf.	1	10	Gencod 3 30380+	€ HT
70	25	139	9252000001	1	10	9252005	15,10	9252001001	1	10	9252012	16,12

9272

POIGNÉE COULISSANTE
T-HANDLE WITH SLIDING SQUARE DRIVE

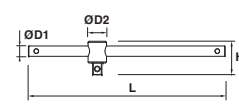

NF ISO 3315 / DIN 3122



L mm	ØD1 mm	ØD2 mm	H mm	g	Réf.	1	10	Gencod 3 30380+	€ HT	Réf.	1	10	Gencod 3 30380+	€ HT
255	13,5	24	45	369	9272250001	1	10	9272256	10,54	9272251001	1	10	9272263	11,47

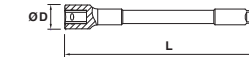

NF ISO 3316 / DIN 3123

9262

RALLONGE
EXTENSION BAR



L mm	ØD mm	g	Réf.	1	10	Gencod 3 30380+	€ HT	Réf.	1	10	Gencod 3 30380+	€ HT
75	24	135	9262070001	1	10	9262073	6,06	9262120001	1	10	9262134	7,30
125	24	225	9262120001	1	10	9262127	6,48	9262250001	1	10	9262264	8,93
250	24	435	9262250001	1	20	9262257	8,05					

9286

POIGNÉE ARTICULÉE GAINÉE 1/2"

HINGED HANDLE 1/2"
Jusqu'à épauement du stock

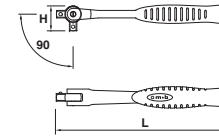

L mm	H mm	g	Réf.	1	10	Gencod 3 30380+	€ HT
250	37	374	9286250001	1	10	9286253	21,80
380	37	569	9286380001	1	10	9286383	26,65

9286

POIGNÉE ARTICULÉE MANCHE
ACIER 1/2"
HINGED HANDLE 1/2"



nouveauté
NEW



L mm	H mm	g	Réf.	1	10	Gencod 3 30380+	€ HT
250	37,5	720	9286250101	1	10	9007544	17,44
380	37,5	720	9286380101	1	10	9007568	21,32

9281

DOUILLE À BOUGIES 6 PANS
SPARK PLUG SOCKET 6 SIDES

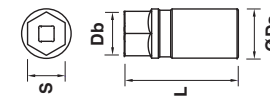

L mm	S mm	ØDb mm	ØDa mm	g	Réf.	1	10	Gencod 3 30380+	€ HT	Réf.	1	10	Gencod 3 30380+	€ HT
67	16	19	22	110	9281160001	1	10	9281166	6,30	9281161001	1	10	9281173	6,89
67	21	24	28	160	9281210001	1	10	9281210	6,78	9281211001	1	10	9281227	7,38

9282

DOUILLE À BOUGIES 12 PANS
SPARK PLUG SOCKET 12 SIDES



L mm	S mm	ØDb mm	ØDa mm	g	Réf.	1	10	Gencod 3 30380+	€ HT
67	16	19	22	110	9282160001	1	10	9290168	6,30
67	21	24	28	160	9282210001	1	10	9290175	6,78

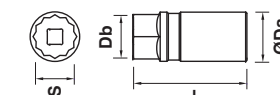

9292

RÉDUCTEUR CARRE 1/2" À 3/8"
COUPLER 1/2" TO 3/8"



L mm	ØD mm	g	Réf.	1	10	Gencod 3 30380+	€ HT
25	24	47	9292380001	1	10	9290137	6,06

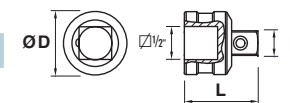



9430-01 9430-03

COFFRETS MÉTALLIQUES DE 19 PIÈCES 1/2"
(cliquet monomatériau)
19 PIECES 1/2" SETS IN METALBOX
(monomaterial ratchet)

9212 / 9215 \odot mm
8-9-10-11-12-13-14-15-16
17-18-19-21-22-24

9202

9252

9262 Lg 125 mm

9262 Lg 250 mm

	Dimensions mm	g	Réf.			Gencod 3 30380+	€ HT
	460 x 190 x 55	4250	9430010001	1	10	9430014	113,62
	460 x 190 x 55	4250	9430030001	1	10	9430038	113,62

9430-02 9430-04

COFFRETS MÉTALLIQUES DE 27 PIÈCES 1/2"
(cliquet monomatériau)
27 PIECES 1/2" SETS IN METALBOX
(monomaterial ratchet)



9212 / 9215 \odot mm
8-9-10-11-12-13-14-15-16
17-18-19-20-21-22-23-24
26-27-29-30-32

9202

9252

9272

9262 Lg 125 mm

9262 Lg 250 mm

	Dimensions mm	g	Réf.			Gencod 3 30380+	€ HT
	460 x 190 x 55	5300	9430020001	1	10	9430021	157,83
	460 x 190 x 55	5300	9430040001	1	10	9430045	157,83

9430-26

COFFRETS PLASTIQUES DE 26 PIÈCES BIMATIÈRE
26 PIECES 1/2" SETS IN PLASTIC BOX

**nouveauté
NEW**



9212 / 9215 \odot mm
8-9-10-11-12-13-14-15-16
17-18-19-21-22-23-24-26-
27-28-29-30-32

9252

9262 Lg 125 mm

9262 Lg 250 mm

	Dimensions mm	g	Réf.			Gencod 3 30380+	€ HT
	360 x 270 x 85	4160	9430260101	1	10	9005762	113,22
	360 x 270 x 85	4160	9430261101	1	10	9005786	113,22
	360 x 270 x 85	4160	9430260001	1	10	9005779	117,14
	360 x 270 x 85	4160	9430261001	1	10	9005793	117,14



9430-27

COFFRETS PLASTIQUES DE 27 PIÈCES BIMATIÈRE 1/2"
27 PIECES 1/2" SETS IN PLASTIC BOX



9212 / 9215 \odot mm
8-9-10-11-12-13-14-16
17-18-19-21-22-24
27-30-32

9272

9252

9262 Lg 125 mm
Lg 250 mm

9281 16-21 mm

9227 13-17-19 mm



	Dimensions mm	g	Réf.			Gencod 3 30380+	€ HT
	360 x 270 x 85	4420	9430270101	1	10	9430069	126,28
	360 x 270 x 85	4420	9430271101	1	10	9004420	126,28
	360 x 270 x 85	4420	9430270001	1	10	9004413	132,25
	360 x 270 x 85	4420	9430271001	1	10	9004437	132,25

9430-50

COFFRETS PLASTIQUES DE 50 PIÈCES BIMATIÈRE 1/2"
50 PIECES 1/2" SETS IN PLASTIC BOX



**nouveauté
NEW**

9212 / 9215 \odot mm
8-10-11-12-13-14-16-17-18-
19-21-22-23-24-27-30-32

9252

9262 Lg 250 mm

9283

919B PH1 PH2-PH3

919A 3-4-4.5-5.5-6.5-8

919C PZ0-PZ1 PZ2-PZ3

919E 1,5-2-2,5 3-4-5-6-8 10

919D T10-T15 T20-T25 T27-T30-T40



	Dimensions mm	g	Réf.			Gencod 3 30380+	€ HT
	360 x 270 x 85	3600	9430500101	1	10	9005724	166,06
	360 x 270 x 85	3600	9430501101	1	10	9005748	166,06
	360 x 270 x 85	3600	9430500001	1	10	9005731	171,57
	360 x 270 x 85	3600	9430501001	1	10	9005755	171,57



DOUILLES TOURNEVIS SCREWDRIVER SOCKETS



9283

**POIGNÉE TOURNEVIS
SPINNER HANDLE**

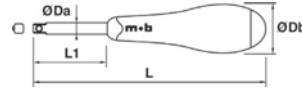

ØDb mm	ØDa mm	L1 mm	L mm	g	Réf.	Ref.	Gencod	€ HT
33	8	51	160	80	9283160001	1	10	9283160 5,57

929A

**DOUILLE PORTE-EMBOUS
6 PANS
BIT HOLDER SOCKET 6 SIDES**

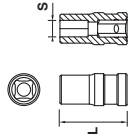

S mm	L mm	g	Réf.	Ref.	Gencod	€ HT
1/4	25	12	929A000101	5	10	9290113 4,37

929A

**DOUILLE TOURNEVIS
À FENTE
SLOTTED SCREWDRIVER
SOCKET**

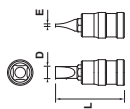

ExD mm	L mm	g	Réf.	Ref.	Gencod	€ HT
0.6x4	32	10	929A060401	5	50	9290014 5,21
0.8x5.5	32	10	929A080401	5	50	9002730 5,21
1x5.5	32	10	929A100401	5	50	9290021 5,21
1.2x7	32	10	929A120401	5	50	9002860 5,21
1.6x8	32	15	929A160401	5	50	9002877 5,21

929B

**DOUILLE TOURNEVIS
DE TYPE PHILLIPS
PHILLIPS TYPE
SCREWDRIVER SOCKET**

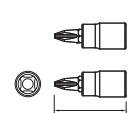

Type mm	L mm	g	Réf.	Ref.	Gencod	€ HT
PH1	32	10	929B010401	5	50	9290038 5,21
PH2	32	10	929B020401	5	50	9290045 5,21
PH3	32	10	929B030401	5	50	9002938 5,21
PH4	32	15	929B040401	5	50	9002945 5,21

929C

**DOUILLE TOURNEVIS
DE TYPE POZIDRIV
POZIDRIV TYPE
SCREWDRIVER SOCKET**

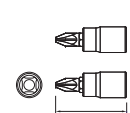

Type mm	L mm	g	Réf.	Ref.	Gencod	€ HT
PZ1	32	10	929C010401	5	50	9290052 5,57
PZ2	32	10	929C020401	5	50	9290069 6,30
PZ3	32	10	929C030401	5	50	9002983 6,30
PZ4	32	15	929C040401	5	50	9002990 6,30

929E

**DOUILLE TOURNEVIS
DE TYPE HEXAGONAL
HEX SOCKET BIT**

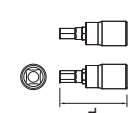

Type mm	L mm	g	Réf.	Ref.	Gencod	€ HT
H2.5	32	9	929E020401	5	50	9003140 5,57
H3	32	9	929E030401	5	50	9290076 5,57
H4	32	10	929E040401	5	50	9290083 5,57
H5	32	10	929E050401	5	50	9290090 5,57
H6	32	15	929E060401	5	50	9290106 5,57
H8	32	15	929E080401	5	50	9002747 5,57

929D

**DOUILLE TOURNEVIS
TYPE TORX
SCREWDRIVER SOCKET
TORX TYPE**

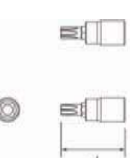

Type mm	L mm	g	Réf.	Ref.	Gencod	€ HT
T8	32	9	929D080401	5	50	9003157 5,80
T9	32	9	929D090401	5	50	9003164 5,80
T10	32	9	929D100401	5	50	9290304 6,01
T15	32	9	929D150401	5	50	9290403 6,01
T20	32	10	929D200401	5	50	9290502 6,23
T25	32	10	929D250401	5	50	9290601 6,23
T27	32	15	929D270401	5	50	9003003 6,45
T30	32	15	929D300401	5	50	9003027 6,45
T40	32	15	929D400401	5	50	9003034 6,45



DOUILLES TOURNEVIS SCREWDRIVER SOCKETS

S inch	L mm	g	Réf.	Ref.	Gencod	€ HT
3/8	25	30	929A000201	5	25	9290281 5,27

929A

**DOUILLE PORTE-EMBOUS
6 PANS
BIT HOLDER SOCKET
6 SIDES**

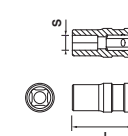

ExD	L mm	g	Réf.	Ref.	Gencod	€ HT
1,6x10	55	65	929A160201	5	50	9002884 10,02
2,0x12	55	75	929A200201	5	50	9002891 10,02
2,5x14	55	110	929A250201	5	50	9002907 10,02
2,5x16	55	110	929A260201	5	50	9002921 10,02

929A

**DOUILLE TOURNEVIS
À FENTE 1/2
SLOTTED SCREWDRIVER
SOCKET**

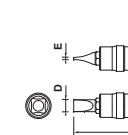

Type mm	L mm	g	Réf.	Ref.	Gencod	€ HT
PH2	55	65	929B020201	5	50	9002952 9,53
PH3	55	65	929B030201	5	50	9002969 9,53
PH4	55	70	929B040201	5	50	9002976 9,53

929B

**DOUILLE TOURNEVIS
DE TYPE PHILLIPS 1/2
PHILLIPS TYPE
SCREWDRIVER SOCKET**

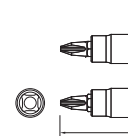

Type mm	L mm	g	Réf.	Ref.	Gencod	€ HT
H5	55	65	929E050201	5	50	9002754 9,36
H6	55	65	929E060201	5	50	9002761 9,36
H7	55	70	929E070201	5	50	9002778 9,36
H8	55	70	929E080201	5	50	9002785 9,36
H9	55	85	929E090201	5	50	9002792 9,36
H10	55	85	929E100201	5	50	9002808 9,70
H12	55	130	929E120201	5	50	9002822 12,29
H14	55	130	929E140201	5	50	9002839 12,29
H17	55	130	929E170201	5	50	9002846 12,48
H19	55	130	929E190201	5	50	9002853 12,61

929E

**DOUILLE TOURNEVIS
DE TYPE HEXAGONAL 1/2
HEX SOCKET BIT**

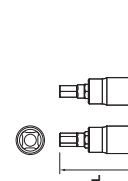

Type mm	L mm	g	Réf.	Ref.	Gencod	€ HT
T27	55	65	929D270201	5	50	9292308 9,51
T30	55	65	929D300201	5	50	9292407 9,53
T40	55	65	929D400201	5	50	9003041 9,53
T45	55	70	929D450201	5	50	9003058 9,53
T50	55	75	929D500201	5	50	9003065 10,02
T55	55	110	929D550201	5	50	9003072 10,02
T60	55	110	929D600201	5	50	9003096 11,54

929D

**DOUILLE TOURNEVIS
TYPE TORX 1/2
SCREWDRIVER SOCKET
TORX TYPE 1/2"**

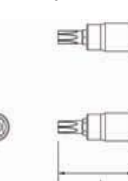

Dimensions mm	L mm	g	Réf.	Ref.	Gencod	€ HT
1/4" : T8- T9-T10-T15- T20-T25-T27-T30. 1/2" : T40-T45- T50-T55-T60-T70	300	700	9413030001	1	10	9413031 87,87

9413

**JEU DE 14 DOUILLES
TOURNEVIS TAMPER
TORX 1/4-1/2 SUR RACK
14 PIECES TAMPER TORX
SCREWDRIVER SOCKET
SET SQUARE 1/4-1/2**

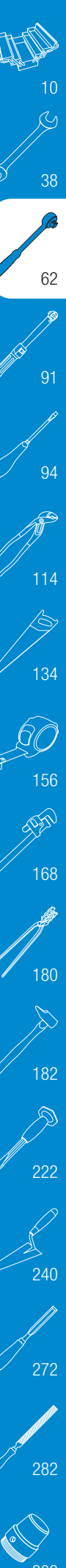

COMPOSITION MIXTE MIXED COMPOSITION



COMPOSITION MIXTE MIXED COMPOSITION



9413-01

COMPOSITION MIXTE
DE 52 PIÈCES
52 PIECES" MIXED
COMPOSITION

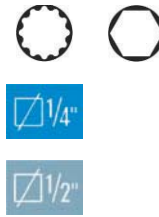

**nouveauté
NEW**

9470

COFFRETS PLASTIQUES
DE DOUILLES
1/2-1/4 56 PCS
56 PIECES" MIXED
COMPOSITION IN
PLASTIC BOX



	9215	mm	10-11-12-13-14-15-16-17 19-21-22-23-24-27-30-32		9210	mm	4-4.5-5-5.5-6-7-8-9 10-11-12-13
	9282	16-21			9200		
	9202				9250		
	9252				9270		
	9262	Lg 50mm			9260	Lg 50 mm	
	9262	Lg 125mm			9260	Lg 125 mm	
	9272				9283		
	919A	0,6 x4 1 x 5,5			919B	PZ1 PZ2	
	919E	H3 - H4 H5 - H6			919D	T30 T40	

Dimensions mm	g	Réf.	1	10	Gencod 3 30380+	€ HT
510 x 240 x 55	6400	9413010001	1	10	9413017	230,99



	9216	mm	4-5-6-7-8-9-10-11-12-13		9215	mm	10-11-12-13-14-16-17-18 19-21-22-24-27-30-32
	9250				9252		
	9270				9272		
	9260	Lg 75 mm			9262	Lg 125 mm	
	9260	Lg 125 mm			9262	Lg 250 mm	
	9260	Lg 150 mm			9262	Lg 250 mm	
	9283				9281	16-21 mm	
	929B	PH1 PH2			929A	0,6 x4 1 x 5,5	
	929E	H3 - H4 H5 - H6			929D	T10-T15 T20-T25 T30-T45	
	9227	Série Longue Long serie 13-17-19 mm					

Dimensions mm	g	Réf.	1	10	Gencod 3 30380+	€ HT
450 x 350 x 90	5650	9470560101	1	10	9413024	184,78
450 x 350 x 90	5650	9470560001	1	10	9004444	193,70
450 x 350 x 90	5650	9470561001	1	10	9004468	193,70



**CLIQUETS, DOUILLES ET ACCESSOIRES TRAVERSANTS :
ACCESSIBILITÉ MAXIMALE**

Gear ratchet composition : maximum of accessibility

PRÉCISION - RAPIDITE - ERGONOMIE

Grâce à sa forme révolutionnaire, ce cliquet à tête traversante et les douilles associées permettent d'atteindre les endroits les plus inaccessibles : les tiges filetées traversent douilles et cliquet et ne gênent plus le serrage. Plus rapide que des clés à pipe débouchées : L'angle de reprise de 5° permet de serrer rapidement dans les espaces restreints.

PRECISE - FAST - ERGONOMIC

Designed with an original shape, this gear ratchet and sockets composition allows an access in the most narrow spaces. The screwed shank cross ratchet and socket and do not hinder tightening. Faster than offset open socket wrenches : 5° increments allows a quick tightening in narrow spaces.

CONVENIENT

2 ratchets in one. Fitted with 2 converters 1/4 and 3/8 square, this ratchet is adapted to any traditional socket.

PRATIQUE

2 cliquets en 1. Grâce à ses 2 adaptateurs de carré et 1/2" 3/8", le cliquet s'adapte à toutes les douilles traditionnelles.

9230

**CLIQUET À TÊTE TRAVERSANTE
HOLLOW RATCHET**

L mm	ØD mm	H mm	g	Réf.	1	25	Gencod 3 30380+	€ HT
205	32,5	11,5	900	9230010001	1	25	9230010	35,50

9231

**DOUILLE TRAVERSANTE
HOLLOW SOCKET**

Ø	L	ØDa	ØDb	g	Réf.	1	25	Gencod 3 30380+	€ HT
10	32	15	19	30	9231100001	1	25	9231000	3,58
11	32	15	19	30	9231110001	1	25	9231017	4,38
12	32	16,5	19	30	9231120001	1	25	9231024	4,38
13	32	18	19	30	9231130001	1	25	9231031	4,38
14	32	19	19	30	9231140001	1	25	9231048	4,70
15	32	20	19	30	9231150001	1	25	9231055	4,70
16	32	21	19	30	9231160001	1	25	9231062	4,70
17	32	22,5	19	35	9231170001	1	25	9231079	4,70
18	32	24	19	35	9231180001	1	25	9231086	4,70
19	33	25	19	40	9231190001	1	25	9231093	4,70

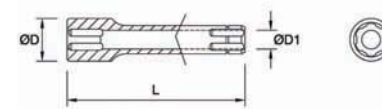

9232

**RALLONGE DÉBOUCHANTE
HOLLOW EXTENSION BAR**

L mm	ØD mm	ØD1 mm	g	Réf.	1	25	Gencod 3 30380+	€ HT
75	25	20	90	9232070001	1	25	9232076	8,19

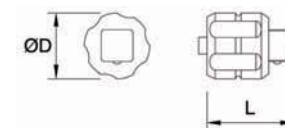

9233

**ADAPTEUR DÉBOUCHANT
OPEN COUPLER 1/4"**

L mm	ØD mm	g	Réf.	1	25	Gencod 3 30380+	€ HT
26	19	35	9233140001	1	25	9233141	6,55

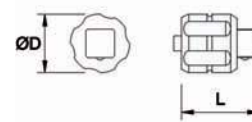

9233

**ADAPTEUR DÉBOUCHANT
OPEN COUPLER 3/8"**

L mm	ØD mm	g	Réf.	1	25	Gencod 3 30380+	€ HT
30	19	45	9233380001	1	25	9233387	8,19

9400-01

**COFFRET PLASTIQUE DE DOUILLES TRAVERSANTES- 14 PIÈCES
14 PIECES HOLLOW COMPOSITION IN PLASTIC BOX**

9231	mm	9233	1/4"
	10-11-12-13-14 15-16-17-18-19		
9230	tête traversante open head	9233	3/8"
9232	Lg 75 mm		

L mm	l mm	H mm	g	Réf.	1	50	Gencod 3 30380+	€ HT
140	305	40	1150	9400010001	1	50	9400000	77,02





CLIQUETS ET DOUILLES 3/4" - 1"

Ratchets and sockets 3/4" - 1"

Cliquets

Compacité facilitant l'accès aux environnements restreints :
 - pour le 3/4" : reprise de 9° (40 dents)
 - pour le 1" : reprise de 10° (36 dents)
 Inverseur de sens encastré : changement contrôlé et d'une seule main
 Manche démontable

Doilles

Doilles montées avec un plongeur "lock pin" : permet de solidariser la douille de l'élément (rallonge, cliquet)
 Rayon de protection du carré : permet de répartir la charge et évite que la douille se casse

Qualité

Doilles 100% forgées tournées
 Fabrication en acier chrome-vanadium, le meilleur matériau pour la fabrication de douilles
 Duretés de 44 à 48 HRC (de 40 à 46 sur 1") et rapport dureté/longévité optimum
 Couple 150% au dessus des normes DIN 3120 et ISO 1174-1

Finition

2 couches de nickel et 1 couche de chrome permet d'absorber les chocs et améliore la tenue de la finition

Coffret

Boîte métallique pour la robustesse
 Une poignée frontale
 Compartiments de rangement et une protection mousse à l'intérieur



Ratchets

Compact tool for an easy access to narrow spaces:
 - 3/4" : 9° increments (40 teeth)
 - 1" : 10° increments (36 teeth)
 Integrated direction reversing system : controlled changing with just one hand
 Handle easy to dismantle

Sockets

Sockets designed with a "lock pin" : links the socket to the accessory (extension bar, ratchet)
 Safety profile of the square : increases the socket resistance thanks to the good spread of the mechanical efforts

Quality

100% forged and turned sockets
 Chrome-vanadium steel manufacturing : the best material for the sockets manufacturing
 Hardness from 44 to 48 HRC (from 40 to 46 for the 1" sockets) and optimum hardness/lifetime product ratio
 150% torque beyond the norms DIN 3120 and ISO 1174-1

Finishing :

2 nickel layers and 1 chrome layer
 To absorb shocks and improve the finishing durability

Box

Strong metallic case
 Front handle
 Individual compartments and foam protection inside



9203

CLIQUET POIRE 3/4"
 RATCHET 3/4"

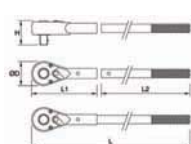

L	I1	I2	ØD	H	g	Réf.	Ref.	Gencod	€ HT
500	150	405	64	57	2800	9203400101	1	10	9001542 104,74



Ø	L	ØDa	ØDb	g	Réf.	Ref.	Gencod	€ HT
22	51	33	36	215	9213220001	1	25	9000972 11,46
24	52	34	36	230	9213240001	1	25	9000996 11,46
27	52	38	36	250	9213270001	1	25	9001023 12,16
28	52	39	36	250	9213280001	1	25	9001030 12,60
29	53	42	38	275	9213290001	1	25	9001047 13,00
30	53	42	38	275	9213300001	1	25	9001054 13,56
32	56	44	38	295	9213320001	1	25	9001078 13,87
36	57	50	42	410	9213360001	1	25	9001337 15,66
38	60	53	45	465	9213380001	1	25	9001344 16,54
41	64	56	45	545	9213410001	1	25	9001368 18,95
46	68	62	47	640	9213460001	1	25	9001382 21,55
50	72	69	47	770	9213500001	1	25	9001399 24,01
55	72	69	49	770	9213550001	1	25	9001405 26,50

Ø	L	ØDa	ØDb	g	Réf.	Ref.	Gencod	€ HT
22	51	33	36	215	9218220001	1	25	9000637 11,46
23	50	34	36	230	9218230001	1	25	9000644 11,46
24	52	34	36	230	9218240001	1	25	9000651 11,46
26	52	37	36	250	9218260001	1	25	9000668 12,00
27	52	38	36	250	9218270001	1	25	9000675 12,16
28	52	39	36	250	9218280001	1	25	9000682 12,60
29	53	42	38	275	9218290001	1	25	9000699 13,00
30	53	42	38	275	9218300001	1	25	9000729 13,56
32	56	44	38	295	9218320001	1	25	9000736 13,87
33	56	46	38	295	9218330001	1	25	9000743 14,50
35	58	48	42	330	9218350001	1	25	9000750 15,00
36	57	50	42	410	9218360001	1	25	9000767 15,66
38	60	53	45	465	9218380001	1	25	9000774 16,54
40	62	54	45	465	9218400001	1	25	9000781 17,90
41	64	56	45	545	9218410001	1	25	9000798 18,95
42	64	57	45	545	9218420001	1	25	9000828 20,20
46	68	62	47	640	9218460001	1	25	9000835 21,55
50	72	69	49	770	9218500001	1	25	9000842 24,01
55	72	69	49	770	9218550001	1	25	9000859 26,50

L mm	ØD mm	g	Réf.	Ref.	Gencod	€ HT
110	40	600	9253000001	1	10	9000538 51,78

L	ØD1	ØD	H	g	Réf.	Ref.	Gencod	€ HT
455	20	37	60	1380	9273450001	1	10	9000590 31,96

L mm	ØD mm	g	Réf.	Ref.	Gencod	€ HT
200	36	715	9263200001	1	10	9000552 19,82
400	36	1350	9263400001	1	10	9000576 24,78

	L mm	ØD mm	g	Réf.	Ref.	Gencod	€ HT
3/4-1/2	54	34	175	9293120001	1	10	9000491 15,49
3/4-1	54	34	175	9293100001	1	10	9000514 16,00

9213

DOUILLE 3/4" 6 PANS
 6 SIDES SOCKET 3/4"

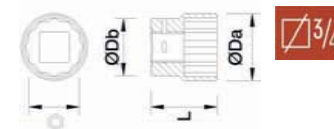

nouveauté
 NEW



9218

DOUILLE 3/4" 12 PANS
 12 SIDES SOCKET 3/4"

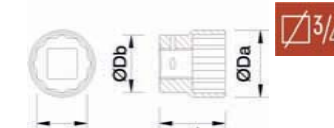

9253

CARDAN DOUILLE 3/4"
 UNIVERSAL JOINT 3/4"

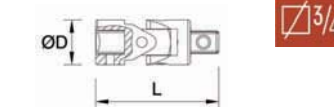

9273

POIGNÉE COULISSANTE 3/4" 450MM
 T-HANDLE WITH SLIDING SQUARE
 DRIVE 3/4"

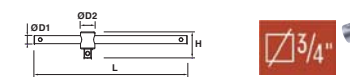

9263

RALLONGE CARRÉ 3/4"
 EXTENSION BAR 3/4"



9293

ADAPTEUR 3/4" => 1/2"
 COUPLER 3/4" TO 1/2"

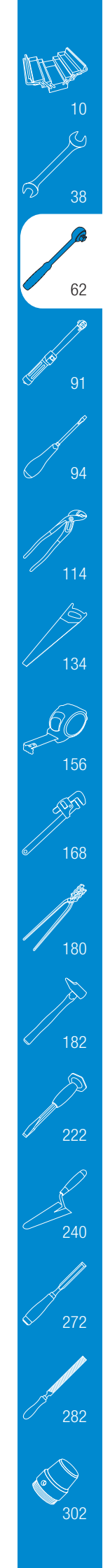

CLIQUETS / DOUILLES / ACCESSOIRES / COMPOSITIONS
RATCHETS / SOCKETS / ACCESSORIES / COMPOSITIONS



3/4"



9440-01
COFFRETS MÉTALLIQUES DE 16 PIÈCES
16 PIECES 3/4" SETS IN METAL BOX

3/4"

9218 9213	mm 22-24-27-30-32-36 38-41-46-50	9253
9203	Lg 200mm - 400mm	9263
9273		9293 3/4"-1/2"

Kg	Réf.			Gencod 3 30380+	€ HT
14	9440020001	1	10	9003409	407,35
14	9440010001	1	10	9000453	407,35

CLIQUET / DOUILLES / ACCESSOIRES / COMPOSITIONS 1"
RATCHET / SOCKETS / ACCESSORIES / COMPOSITIONS 1"



9204
CLIQUET POIRE 1"
RATCHET 1"

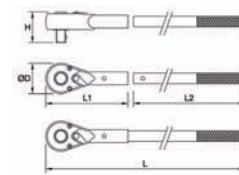

L mm	I1	I2	ØD mm	H mm	g	Réf.			Gencod 3 30380+	€ HT
765	195	635	79	67	5600	9204360101	1	10	9001559	179,43



9214
DOUILLE 1" 6 PANS
6 SIDES SOCKET 1"

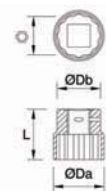

1"

mm	L mm	ØDa mm	ØDb mm	g	Réf.			Gencod 3 30380+	€ HT
36	65	53	45	480	9214360001	1	25	9001429	29,42
41	71	57	45	570	9214410001	1	25	9001436	31,64
46	76	65	50	805	9214460001	1	25	9001443	33,94
50	78	71	55	965	9214500001	1	25	9001450	36,25
55	81	77	57	1145	9214550001	1	25	9001467	44,65
60	84	82	57	1285	9214600001	1	25	9001474	50,78
65	89	89	57	1490	9214650001	1	25	9001481	62,16
70	94	94	68	1895	9214700001	1	25	9001498	69,64
75	98	100	68	2140	9214750001	1	25	9001504	78,62
80	104	105	68	2285	9214800001	1	25	9001528	88,25



1"

CLIQUET / DOUILLES / ACCESSOIRES / COMPOSITIONS
RATCHET / SOCKETS / ACCESSORIES / COMPOSITIONS

mm	L mm	ØDa mm	ØDb mm	g	Réf.			Gencod 3 30380+	€ HT
36	65	53	45	480	9219360001	1	25	9000866	29,42
41	71	57	45	570	9219410001	1	25	9000873	31,64
46	76	65	50	805	9219460001	1	25	9000880	33,94
50	78	71	55	965	9219500001	1	25	9000897	36,25
55	81	77	57	1145	9219550001	1	25	9000903	44,65
60	84	82	57	1285	9219600001	1	25	9000927	50,78
65	89	89	57	1490	9219650001	1	25	9000934	62,16
70	94	94	68	1895	9219700001	1	25	9000941	69,64
75	98	100	68	2140	9219750001	1	25	9000958	78,62
80	104	105	68	2285	9219800001	1	25	9000965	88,25

9219
DOUILLE 1" 12 PANS
12 SIDES SOCKET 1"

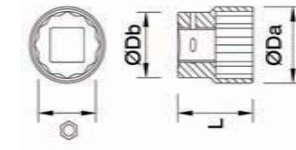

L mm	ØD mm	g	Réf.			Gencod 3 30380+	€ HT
140	49	750	9254000001	1	10	9000545	115,05

9254
CARDAN DOUILLE 1"
UNIVERSAL JOINT 1"

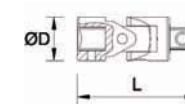

L mm	ØD1 mm	ØD2 mm	H mm	g	Réf.			Gencod 3 30380+	€ HT
560	28	49	80	3300	9274550001	1	10	9000620	58,60

9274
POIGNÉE COULISSANTE 1"
T-HANDLE WITH SLIDING SQUARE DRIVE 1"

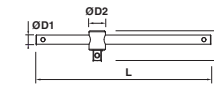

L mm	ØD mm	g	Réf.			Gencod 3 30380+	€ HT
200	48	1300	9264200001	1	10	9000569	41,86
400	48	2300	9264400001	1	10	9000583	52,40

9264
RALLONGE CARRÉ 1"
EXTENSION BAR 1"

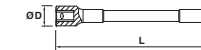

L mm	ØD mm	g	Réf.			Gencod 3 30380+	€ HT
68	48	425	9294340001	1	10	9000521	36,10

9294
ADAPTEUR 1" => 3/4"
COUPLER 1" TO 3/4"

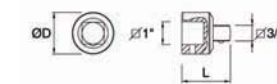

9450-01
COFFRETS MÉTALLIQUES DE 17 PIÈCES
17 PIECES 1" SETS IN METAL BOX

coffret métallique avec verrouillage de sécurité
2 poignées latérales
metallic case with safety locking
2 lateral handles

9219 9214	mm 36-41-46-50-55-60 65-70-75-80	9254
9204	Lg 200mm - 400mm	9264
9274		9294 1"-3/4"

	g	Réf.			Gencod 3 30380+	€ HT
33930	9450020001	1	10	9003416	899,01	
33930	9450010001	1	10	9000460	899,01	



SÉRIE IMPACT

IMPACT RANGE



DOUILLES IMPACT

nouveauté
NEW

Impact Sockets

Conçues pour résister aux contraintes des outils électroportatifs : clés à chocs, visseuses, ...

Specially designed to use with air or electric power tools.



Acier de qualité et traitement thermique garantissant une très grande résistance et une longue durée de vie

Conformes aux normes DIN 899, DIN 3121 et DIN 3129

Very high yield strength and resistance: quality steel and heat treatment. Conformity to norms: DIN 899, DIN 3121 & DIN 3129.



9212

DOUILLES IMPACT 1/2"
6 SIDES IMPACT SOCKET 1/2"

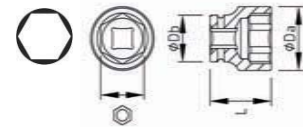

nouveauté
NEW



Ø mm	ØDb mm	Ø Da mm	L mm	Réf.	⊞	⊞	Gencod 3 30380+	€ HT
8	25	15	38	9212080501	1	25	1700528	5,52
10	25	17	38	9212100501	1	25	1700993	5,92
11	25	18.5	38	9212110501	1	25	1700481	5,92
12	25	20	38	9212120501	1	25	1700726	5,92
13	25	21	38	9212130501	1	25	1700955	7,05
14	25	22.5	38	9212140501	1	25	1700443	7,05
15	30	23	38	9212150501	1	25	1700658	7,05
16	30	25	38	9212160501	1	25	1700917	7,05
17	30	26	38	9212170501	1	25	1700412	7,41
18	30	27.5	38	9212180501	1	25	1700627	7,41
19	30	28.5	38	9212190501	1	25	1700894	7,41
21	30	31	38	9212210501	1	25	1700597	7,80
22	30	32.5	38	9212220501	1	25	1700856	7,80
24	30	35	38	9212240501	1	25	1700566	8,63
27	30	38.5	45	9212270501	1	25	1700535	9,70
28	30	40	47	9212280501	1	25	1700740	13,58
30	30	42	50	9212300501	1	25	1700498	13,58
32	30	44	50	9212320501	1	25	1700962	13,58



9222

DOUILLES IMPACT LONGUES 1/2"
6 SIDES IMPACT SOCKET LONG 1/2"

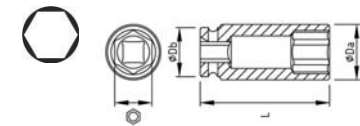

nouveauté
NEW



Ø mm	ØDb mm	Ø Da mm	L mm	Réf.	⊞	⊞	Gencod 3 30380+	€ HT
10	25	17	80	9222100501	1	25	1700863	14,68
11	25	18.5	80	9222110501	1	25	1701068	15,36
13	25	21	80	9222130501	1	25	1700801	17,43
14	25	22.5	80	9222140501	1	25	1701044	17,63
16	30	25	80	9222160501	1	25	1700757	17,79
17	30	26	80	9222170501	1	25	1701006	17,98
18	30	27.5	80	9222180501	1	25	1700504	18,35
19	30	28.5	80	9222190501	1	25	1700733	19,47
21	30	31	80	9222210501	1	25	1700450	20,64
22	30	32.5	80	9222220501	1	25	1700665	20,98
24	30	35	80	9222240501	1	25	1700429	21,30
27	30	38.5	80	9222270501	1	25	1701082	22,29
28	30	40	80	9222280501	1	25	1700603	23,58
30	30	42	80	9222300501	1	25	1701075	24,83
32	30	44	80	9222320501	1	25	1700818	28,13



nouveauté
NEW



L mm	ØD mm	Réf.	⊞	⊞	Gencod 3 30380+	€ HT
58.5	30	9252000501	1	10	1701020	33,01

nouveauté
NEW



L mm	ØD mm	Réf.	⊞	⊞	Gencod 3 30380+	€ HT
75	25	9262070501	1	10	1701037	31,05
125	25	9262120501	1	10	1700719	48,27
250	25	9262250501	1	10	1700795	48,69

nouveauté
NEW



ØF mm	ØM mm	L mm	ØD mm	Réf.	⊞	⊞	Gencod 3 30380+	€ HT
1/2"	3/4"	45	25	9292340501	1	10	1700931	18,74

nouveauté
NEW



Dimensions mm	Réf.	⊞	⊞	Gencod 3 30380+	€ HT
10-11-12-13-14-17-19-21-22-24 mm	9212010501	1	10	9007599	70,91

9252

CARDAN UNIVERSEL IMPACT 1/2"
IMPACT UNIVERSAL JOINT 1/2"

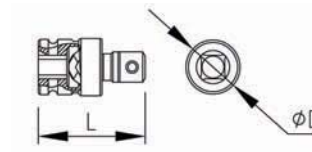

9262

RALLONGE IMPACT 1/2"
IMPACT EXTENSION BAR 1/2"

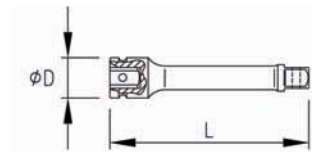

9292

ADAPTEUR IMPACT 1/2" > 3/4"
IMPACT COUPLER 1/2" TO 3/4"

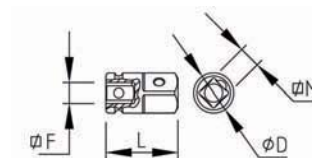

9212

COFFRET MÉTAL DE 10 DOUILLES
IMPACT 1/2"
6 SIDES IMPACT SOCKET SET 1/2",
10 PCS.



SERIE IMPACT

IMPACT RANGE



9213

DOUILLES IMPACT 3/4"
6 SIDES IMPACT SOCKET 3/4"

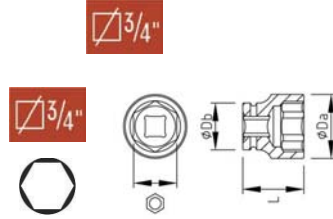

nouveauté
NEW

Ø mm	ØDb mm	ØDa mm	L mm	Réf.	⊞	⊟	Gencod 3 30380+	€ HT
19	44	32.5	51	9213190501	1	25	1700573	13,96
22	44	36	51	9213220501	1	25	1700542	14,22
23	44	37.5	51	9213230501	1	25	1700764	14,69
24	44	38.5	51	9213240501	1	25	1701013	15,36
27	44	42.5	53	9213270501	1	25	1700979	17,43
28	44	44	53	9213280501	1	25	1700467	17,63
29	44	45	53	9213290501	1	25	1700672	17,79
30	44	46	53	9213300501	1	25	1700924	17,97
32	44	48.5	57	9213320501	1	25	1700634	18,36
33	44	50	57	9213330501	1	25	1700900	19,47
34	44	51	57	9213340501	1	25	1701099	20,65
35	44	52.5	57	9213350501	1	25	1700610	20,97
36	44	53.5	57	9213360501	1	25	1700870	21,30
38	44	56	57	9213380501	1	25	1700580	22,29
41	44	60	58	9213410501	1	25	1700559	23,59
42	44	61	58	9213420501	1	25	1700771	24,82
46	44	66	62	9213460501	1	25	1700986	28,13



9223

DOUILLES IMPACT LONGUES 3/4"
6 SIDES IMPACT SOCKET LONG 3/4"

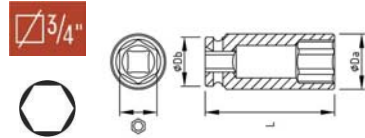

nouveauté
NEW

Ø mm	ØDb mm	ØDa mm	L mm	Réf.	⊞	⊟	Gencod 3 30380+	€ HT
17	44	30	90	9223170501	1	25	1700689	21,95
19	44	32.5	90	9223190501	1	25	1700436	22,33
22	44	36	90	9223220501	1	25	1701105	23,12
24	44	38.5	90	9223240501	1	25	1700887	23,12
27	44	42.5	90	9223270501	1	25	1700825	23,94
30	44	46	90	9223300501	1	25	1700788	27,76
32	44	48.5	90	9223320501	1	25	1700511	29,07
36	44	53.5	90	9223360501	1	25	1700696	33,50
41	44	60	90	9223410501	1	25	1701112	38,85
46	44	66	90	9223460501	1	25	1700832	45,82



9253

CARDAN UNIVERSEL IMPACT 3/4"
IMPACT UNIVERSAL JOINT 3/4"

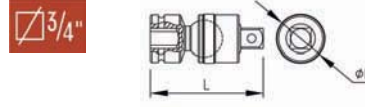

nouveauté
NEW

L mm	ØD mm	Réf.	⊞	⊟	Gencod 3 30380+	€ HT
106	44	9253000501	1	10	1700702	67,11



9263

RALLONGE IMPACT 3/4"
IMPACT EXTENSION BAR 3/4"

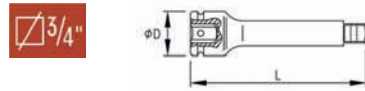

nouveauté
NEW

L mm	ØD mm	Réf.	⊞	⊟	Gencod 3 30380+	€ HT
175	44	9263170501	1	10	1700849	67,12
250	44	9263250501	1	10	1700474	52,02



9293

ADAPTATEUR IMPACT 3/4"
IMPACT ADAPTER 3/4" TO 1", 1/2"

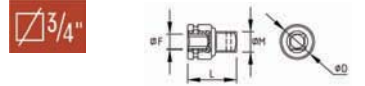

nouveauté
NEW

ØF mm	ØM mm	L mm	ØD mm	Réf.	⊞	⊟	Gencod 3 30380+	€ HT
3/4"	1"	63	44	9293100501	1	10	1700948	48,69
3/4"	1/2"	58	44	9293120501	1	10	1700641	26,67



9294

ADAPTATEUR IMPACT 1" > 3/4"
IMPACT COUPLER 1" TO 3/4"

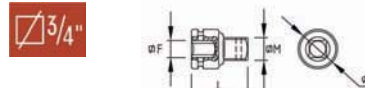

nouveauté
NEW

ØF mm	ØM mm	L mm	ØD mm	Réf.	⊞	⊟	Gencod 3 30380+	€ HT
1"	3/4"	66	54	9294340501	1	10	1701051	48,47